

PRODUCT GUIDE

STRUCTURED WIRING

Enclosures, Data, Phone, Video

HOME INTERCOM SYSTEMS

Front Door and CAT5 Intercoms

SURVEILLANCE SOLUTIONS

IP Cameras, Analog Cameras, DVRs, NVRs

ENTERTAINMENT

Whole House Audio, Speakers, IR Repeaters



234 Fischer Ave.
Costa Mesa, CA 92626 USA
800.840.0288 • 714.424.6500
sales@channelvision.com
www.channelvision.com

ABOUT US

Founded in 1993 and ranked among the top companies in the custom electronics industry, Channel Vision Technology is a leading manufacturer of innovative technology products in Home Automation, Surveillance Systems, Structured Wiring, Home Intercom Systems, IR Remote Control and Audio Distribution for both residential and commercial applications.

Our broad-range of electronic solutions are designed to provide lifestyle enhancements for residents, while equipping homes and businesses for greater safety, convenience and entertainment.

MARKET'S SERVED



MDU (Multi-Dwelling Units)

- RF & Video Distribution
- Structured Wiring
- Audio Distribution
- Intercom Systems



Commercial Buildings

- Camera Surveillance
- Audio Distribution
- Structured Wiring



New Home Construction

- RF & Video Distribution
- Audio Distribution
- IR System Control
- Structured Wiring
- Intercom System
- Camera Surveillance

SERVICES



20-Year Certified Extended Warranty Program

- Includes all passive Structured Wiring in certified installs
- Confidently design, trouble-shoot & certify systems
- Free CEU certification courses
- Efficient installs, higher profits & added value
- Become a Certified Installation Specialist & receive referral leads, marketing support & special promotions



Channel Vision 5 Star Program

- 24/7/365 technical support
- 1/10/20 year warranties
- Free panel design & system layout
- Custom manufacturing
- CEDIA, BISCSI & NBFAA approved trainings with continuing education credit



Builder Advantage Program

- Well-connected home marketing
- Model home and showroom display discounts
- Large selection available with pre-packaged systems



Web Support:
www.channelvision.com



Phone Support:
(800) 840-0288 or (714) 424-6500



Email Support:
techsupport@channelvision.com

DEALER PROGRAMS

At Channel Vision, we always have our dealers bottom line in mind. All of our dealer programs are designed to make doing business with Channel Vision as simple and profitable as possible. Channel Vision is the best in the industry at accomodating our dealers needs and we have the programs to provide it.

TRADE UP YOUR TECHNOLOGY

- Enjoy a 30% trade in discount on the next-generation product upgrade
- No time lines to conform to an upgrade
- Product can be working or in non-working condition
- Our entire line of products are eligible (hard-drives excluded)

Custom Panel Design Services

- Channel Vision's technical team will design a custom solution for your project
- We provide a CAD drawing together with a recommended parts list
- Save time, resources and money

Model Home Discount Program

- Install our technology in a home development and we discount the products
- Exclusive program for all authorized Channel Vision dealers
- Discounts on wall plates, connectors & structured wiring products

Showroom Demo Discount

- Exclusive program for all authorized Channel Vision dealers
- Demonstration discounts for your showroom

STRUCTURED WIRING



Structured wiring systems by Channel Vision feature modular connected home wiring systems and components that are easy to install and upgrade. Commercial and residential wiring has never been easier with components that effortlessly snap into place.

FEATURES AND BENEFITS

- One of the largest selections of structured wiring enclosures on the market
- Push-and-Lock Modules for cameras, video, voice, data, power, fiber optics, audio and communication
- Solid steel construction with a pure white powder coated finish.

CORE COMPONENTS

WIRING ENCLOSURES



DATA DISTRIBUTION



VIDEO DISTRIBUTION



PHONE DISTRIBUTION



FREE SYSTEM DESIGN SERVICE

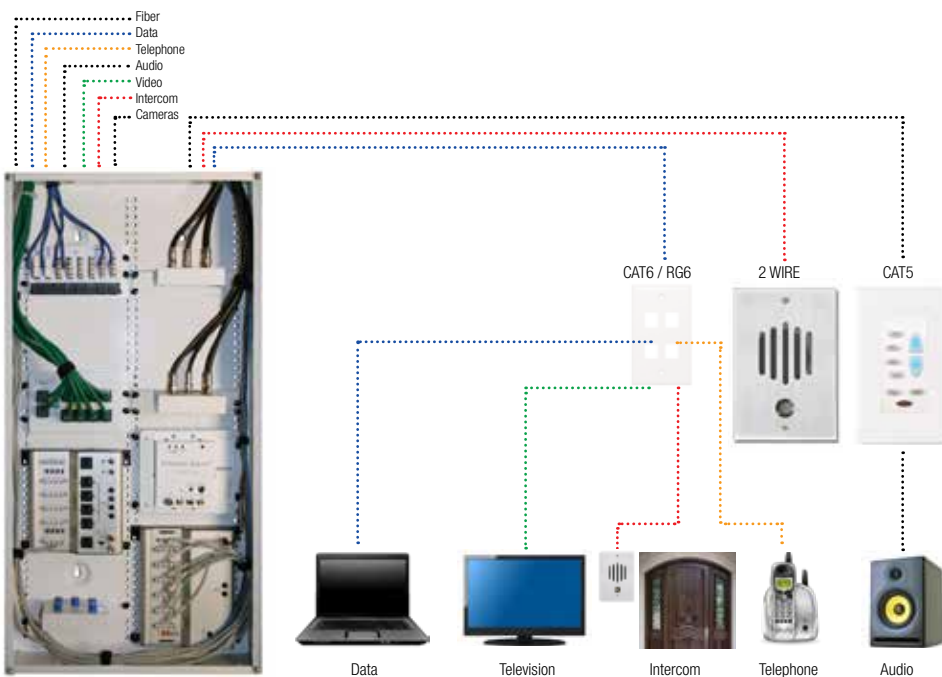

3 Quick and Easy Steps to a Complete System

1. Visit the website at channelvision.com and complete the form
2. We'll send you a complete system design and a list of product needed
3. Submit the list of products needed to your dealer or distributor

For an authorized dealer or distributor near you, visit channelvision.com or call (800) 840-0288



Web Support:
www.channelvision.com



Phone Support:
(800) 840-0288 or (714) 424-6500



Email Support:
techsupport@channelvision.com

ENCLOSURES



Structured Wiring Enclosures

Solid steel with a pure white powder coated finish.



12" - C-0112E



19" - C-0119E



28" - C-0128E



38" - C-0138E



50" - C-0150E

ENCLOSURE COVERS



Screw Down Covers

The Screw down cover extends beyond the edge of the enclosure to conceal drywall cuts.

12" - C-0112C
19" - C-0119C



Hinged Cover w/Lock

19" - C-0119HC 38" - C-0138HC
28" - C-0128HC 50" - C-0150HC



NEW 12" Plastic Enclosure & Cover

Perfect for wireless signals.

C-0113 - 12"x14" x 3.5"



Design Covers

Designer Hinged Doors provide an attractive alternative to the standard covers.

28" - C-0128D
38" - C-0138D
50" - C-0150D



Double Hinged Door

Hinged Double Door for the 38" enclosure is split so either the top, bottom or both sections can be opened at any time.

38" - C-0138DD



50" Extension Ring

Channel Vision's 50" Depth Extension Ring makes the enclosure 2" deeper.

C-1351 - 50" - 1.75" depth
C-1355 - For Bose® mounting plate

ENCLOSURES ACCESSORIES



Vertical/Horizontal Bracket

C-0308 - 12" x 5-1/2" Horizontal
C-0309 - 6" x 9" Vertical



Snap Pin Mini Grip

C-1302



Universal Product Holder

C-1311 - 6-3/8" x 3-1/4"
C-1312 - 11-3/4" x 3-1/4"



Grid Lifting Chase Module

C-1320 - 6.5" x 13.25"



Hinged Expansion

C-1321 - 13" x 13" (For C-1351)
C-1332 - For Bose® Amplifier



Fan Kit for Designer Doors

C-1322



Universal Hinge Kit

C-1324



Mounting Clips for Steel Studs

C-1328 for 3/8" Steel Studs
C-1329 for 1/2" Steel Studs
C-1330 for 5/8" Steel Studs



Mounting Plates

C-1327 - Universal PCB Mounting System
C-1331 - Mounting Bracket for Bose® connection center
C-1332 - Hinged Mount for Bose® Amp



Lock & Key Kit

C-1350 - 50" HC
C-1352 - 19", 28", 38" HC

DATA & POWER DISTRIBUTION MODULES



NEW 8x8 CAT6 Data Patch Panel
C-0538



NEW 4-Port Wireless N Router
C-0554



NEW 5-Port 10/100 Switch
C-0555



6x6 CAT5 Data Patch Panel
C-0575



NEW 8-Port Gigabit Switch
C-0588



Powerstrip Modules
C-0702 - Vertical Plug
C-0705 - Horizontal Plug

COAXIAL SPLITTERS, TAPS AND AMPLIFIERS



RF 1GHz Splitter
C-0202 - 2 Way C-0204 - 4 Way
C-0208 - 8 Way C-0332 - 16 Way



'F' Barrel Modules 2GHz
C-0213



C-0214 - 1x6 RJ45 / 1x4 Coax **COMBO**
C-0216 - 1x6 Phone / 1x4 Coax



Home Office Module 4x4 RJ45 / 1x2 Coax **COMBO**
C-0215



1x15 Phone & 1x4 Video Module **COMBO**
C-0219



Basic Structured Wiring System
C-0221



1x7 Phone & 8 TV Distribution **COMBO**
C-0227



High Frequency 2GHz Splitter Module
C-0232 - 2 Way C-0234 - 4 Way



Return Path Amplifier
C-0300



Amplified Splitter Module
C-0310 - 10dB Amp
C-0314 - 8dB Amp all 4



Multimedia Cable Amp 15dB
C-0317



1x16 Amplified Splitter Module
C-0332



8 Out Bi-Directional Amplified Splitter
C-0333



Cable TV Amplifier 40dB
C-0340



Vertical Splitters
HS-6V - 6 Way HS-8V - 8 Way



Line Tap
TP6dB TP16dB TP24dB
TP12dB TP20dB



2x8 Multimedia Amplified Splitter / Combiner
CVT-2/8WB



1 in 1 Out 15dB Multimedia Amplifier
CVT-15WB



40dB RF Amplifier
CVT-40BD



RF Splitters
HS-2 - 2 Way HS-4 - 4 Way HS-8 - 8 Way
HS-3 - 3 Way HS-6 - 6 Way HS-16 - 16 Way

FIBER OPTICS



NEW Fiber Optics Spool Module
C-0622



Speaker Distribution Module
C-1001



IR Repeater Distribution Module
C-1201

Multimedia on Coax
Multimedia amplifiers work with 5-1525 MHz Verizon Fios® systems

TELEPHONE DISTRIBUTION MODULES



RJ31X Module
C-1333



Strain Relief Clips for 110
C-1325



Lightning/Surge Protection
C-0410



DSL Filter Surge Protection with RJ31X
P-0411



4x8 110 Phone with RJ31X
C-0432



4x8 RJ45 Phone with RJ31X
C-0436



4x12 RJ45 Phone with RJ31X
C-0437



Tele Dist. 4x7
C-0438



110 Tel. Dist. 4x15
C-0439



100 Pair Phone with RJ31X
C-0441



1x6 Economy RJ45 Phone Distribution
C-0476



**1x6 Economy 110 Punch Down
Phone Distribution**
C-0478

KSU TELEPHONE DISTRIBUTION



KSU Phone Dist. Module
C-0434



Telco to RJ14 Converter
C-0497



Pre-Wired Octopus Cable
C-0498



KSU Expansion PCB
C-0499

RF MODULATION & VIDEO DISTRIBUTION



1-Input Micro Modulator
E1200
C-0301 - On Bracket for Enclosure

- 25dBmV output
- Wide channel range cable 65-135 (excluding 95-99) UHF 14-78
- Push button channel selector



2 / 4 Input Modulator
E2200IR / E4200IR
C-0352/C-0354 - On Bracket

- 25dBmV output
- Wide channel range cable 65-135 (excluding 95-99) UHF 14-78
- Built in IR engine for use with the IR-4101



**2x1 RF Combiner with
IR Controlled Switch**
P-0321

- Source switching between cable and modulator (or Antenna)
- IR engine over coax built-in



Affinity Mini Remote
A0511



**Affinity 3x8 Amplified Splitter
and Modulator Cable Combiner**
P-0328

- Combines cable TV with modulated signals and amplifies up to 8 outputs
- Eliminates cable interference without filters to block channels
- IR engine over coax built-in



IR Repeater over Coax Kit
IR-4500
Channel Vision's IR Repeater over Coax Starter Kit transforms your existing coax wiring into a whole house IR infrastructure.



75 ft. Amplified Component Cables
P-1400

- Amplifies component, composite, S-Video for quick legacy product installation
- Pre-connected connectors S-Video, component, composite, IR 3.5mm



1-Input MTS Stereo
CVT1Stereo-II

- 1-Input, table-top design, stereo audio
- Full 30+dBmV output (adjustable)
- LED Channel Display
- Video level adjustment



**Audio/Video Baseband
Distribution**
VDA-12

- 1 in 12 out
- High power output drive stage
- 500 lines resolution
- Video gain adjustable

WALLPLATES

STANDARD IVORY



J-1GI J-2GI J-3GI J-4GI J-6GI

STANDARD ALMOND



J-1GA J-2GA J-3GA J-4GA J-6GA

STANDARD WHITE



G-1GW G-2GW G-3GW G-4GW G-6GW

DECORATOR IVORY w/ICONS



J-1DGI J-2DGI J-3DGI J-4DGI J-6DGI

DECORATOR ALMOND w/ICONS



J-1DGA J-2DGA J-3DGA J-4DGA J-6DGA

DECORATOR LIGHT ALMOND w/ICONS



J-1DGLA J-2DGLA J-3DGLA J-4DGLA J-6DGLA

DECORATOR WHITE w/ICONS



G-1DGW G-2DGW G-3DGW G-4DGW G-6DGW

OVERSIZE LIGHT ALMOND



J-1GOLA J-2GOLA J-3GOLA J-4GOLA J-6GOLA

OVERSIZE WHITE



G-1GOW G-2GOW G-3GOW G-4GOW G-6GOW



Snap-On Icon Labels included with Decorator Wallplates.



IR Breakout Insert
G-IRB-W
J-IRB-I
J-IRB-A



F Connector
2002



F and Telephone
2009



Cable Port
G-1CDW



7.2 Home Theater
CC-272



7.2 Home Theater w/Inserts
CC-372

WALLPLATE INSERTS & CONNECTORS



Black Banana Jack
G-BJB-W (White)
J-BJB-A (Almond)
J-BJB-I (Ivory)



Red Banana Jack
G-BJR-W (White)
J-BJR-A (Almond)
J-BJR-I (Ivory)



Banana Plug
J-BPB (Gold Plated Black)
J-BPR (Gold Plated Red)



F to RCA
G-IF/RCW (White)
J-IF/RCAA (Almond)
J-IF/RCAI (Ivory)



RCA to RCA
G-IRCA-W (White)
J-IRCA-A (Almond)
J-IRCA-I (Ivory)



BNC to BNC
G-IBNC-W (White)
J-IBNC-A (Almond)
J-IBNC-I (Ivory)



6P4C, RJ-14, 110
G-C3AW (White)
J-C3AA (Almond)
J-C3AI (Ivory)
J-C3ALA (Light Almond)



CAT5, 8P8C, 110
G-C5AW (White) J-C5AI (Ivory)
J-C5AA (Almond) J-C5AB (Blue)
J-C5ALA (Light Almond)



CAT6, 8P8C
G-C6AW (White) G-C6AR (Red)
G-C6AB (Blue) G-C6AY (Yellow)
G-C6AG (Green)



C5 Connector
J-101-88



C5 Shielded Connector
J-101-85-C5



RJ14 6P6C Round Wire
J-66-C3

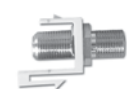

F to F Connector
G-IFCW (White)
J-IFCA (Almond)
J-IFCI (Ivory)
J-IFCLA (Light Almond)



Blank Insert
G-I-B-W (White)
J-I-B-A (Almond)
J-I-B-I (Ivory)
J-I-B-LT (Light Almond)

TOOLS & CONNECTORS



RF Connectors Kit
1000 RF Kit A



F Connector Tool
1003



Coax Stripper
1004 - Stripper
1004 - Blade



RF Tool & Connector Kit
1005



Crimp Tool for RG59, 58, 6
1011



110 Punch & Strip Tool
J-110-TOOL



Quad Crimp RG6
1012



Crimp Tool CAT5
1014



F Tool - Snap & Seal
(2133 & 2134 Only)
1015



Coax Cutter Tool
1016



Punch Down Tool - 110
1017



RG6 Cable Clip with Nail
1115- Black
1116- White



F-Male Terminator 75 ohm
2101



Double Female F-Splice
2102



RG59 Crimp F-Connector
2103



RG6 Crimp F-Connector
2104 - Corrugated
2104C - Compression
2104QS - Quad Shield



F-Female to BNC Male
2105



RG59 BNC Twist On
2106



BNC Three Female
2107



BNC Double Female
2108



BNC 75ohm Terminator
2109



BNC Male Twist on for RG6
2110



BNC Crimp on for RG6
2113



BNC Crimp on for RG59
2114



F to UHF Adaptor
2115



BNC Crimp 3-Piece
2116



BNC Crimp On RG59 Female
2117



BNC Female 2 Piece Plenum
2118



BNC Male 2 Piece Plenum
2119



BNC "T" 2 Female, 1 Male
2120



BNC Ferrule for RG6
2122



BNC Right Angle
2123



F Connector Right Angle
2125



F Female to RCA Male
2126



RCA Female to BNC Male
2127



BNC Female to RCA Male
2129



RG6 Interconnect
2131 Q11 - 11"
2131 Q17 - 17"
2131 Q24 - 24"



Push & Seal F Connector
2133 - Black
2134 - Quad Blue



HQ F-Connector with Gold Center Pin
2140 HQ
2141 HQ - Solderless Cable



NEW Female 2.1mm Power Supply Adapter
2143F



NEW Male 2.1mm Power Supply Adapter
2144M



F-Connect Ground Block
2201



Dual F-Connect Ground Block
2202



F to F Male Coupler
2203



Attenuator
3000-3 - 3db 3000-10 - 10db
3000-6 - 6db 3000-20 - 20db



Cable Box Combiner
3101



Low Pass Filter Blocks Below Channel 60
3102-60



"Y" Connector for Splitting Audio & Video
3104 HQ (Gold Plated)



RCA Y Compensator 1kΩ
3107



DC Block
3109



Tilt Compensator
3110-TILT



CAT5 Balun
3112



CAT5 RJ45 Interconnect
C-0408 - 1'
C-0409 - 3'

HOME INTERCOM SYSTEMS



Channel Vision's Home Intercom System provides direct room-to-room communication and a variety of features not offered by other systems - including a remote control for hands-free calls making whole-house communication from anywhere in the room convenient.

FEATURES AND BENEFITS

- High quality door stations are made from 1/4" solid brass providing a luxurious addition to any front door or access point.
- Provides 2-way conversation between front door intercom and every telephone in the house. Simply pick up the phone and begin speaking to the person at the front door.
- By adding a camera, you're able to see and speak to visitors before allowing them into your home.
- Call forwarding module allows you to answer the intercom from your cell phone or office.

UNDERSTANDING THE MODEL NUMBERS

Part numbering: DP, IU, and DS3 door plates

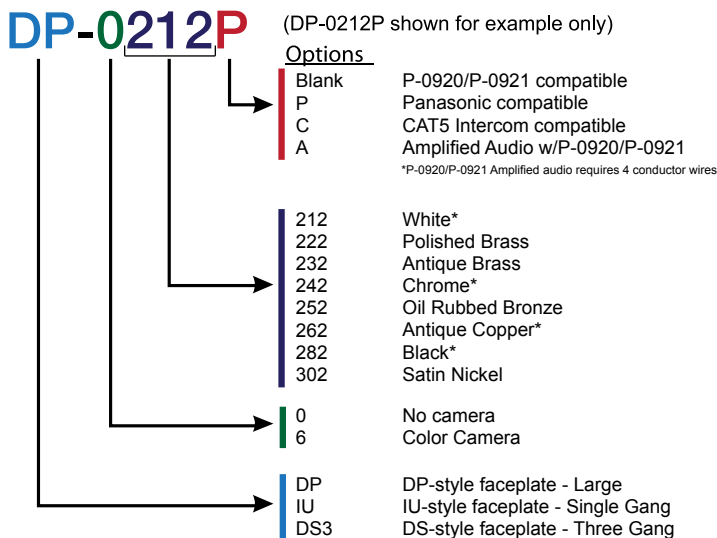

*Not Available in DS3 Series

AVAILABLE FINISHES





FRONT DOOR INTERCOM SET-UP

The P-0921 provides communication between two different Channel Vision door intercoms and any phone in the house. When a visitor presses the doorbell button, the phone in the house will respond with a distinctive ring. The homeowner can then speak to the visitor by answering any of the ringing phones in the house.

- Built-in door strike relay
- Doorbell chime output
- Paging through audio system
- Automatic triggering relay

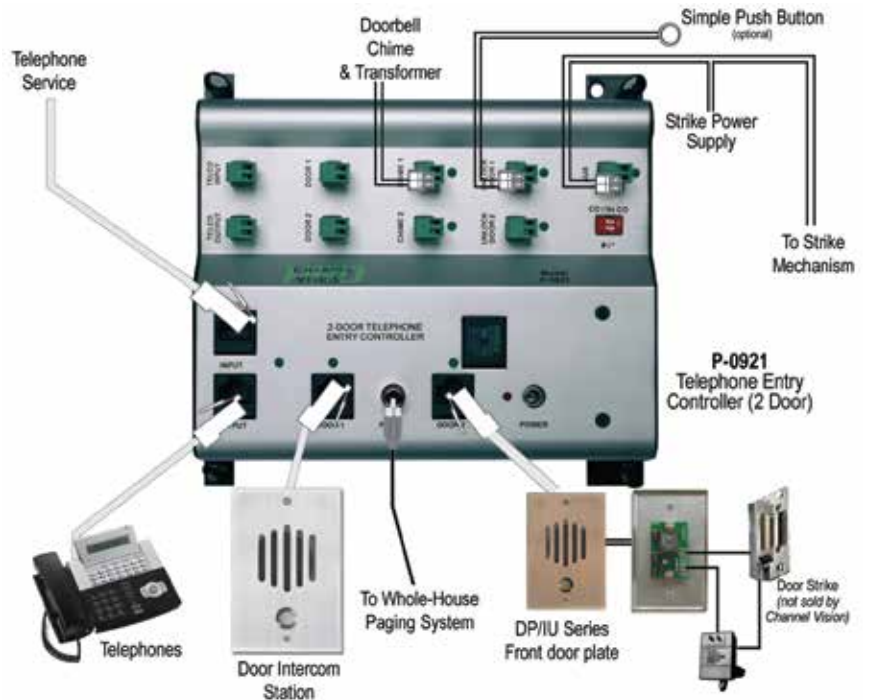

CAT5 INTERCOM SET-UP

- Up to 2 doors and 22 stations
- IR remote control of room stations
- Modes - Monitor, DND, and privacy
- Hands-free communication
- Paging through the whole-house, specific room or audio system
- Single CAT5 wire to each station

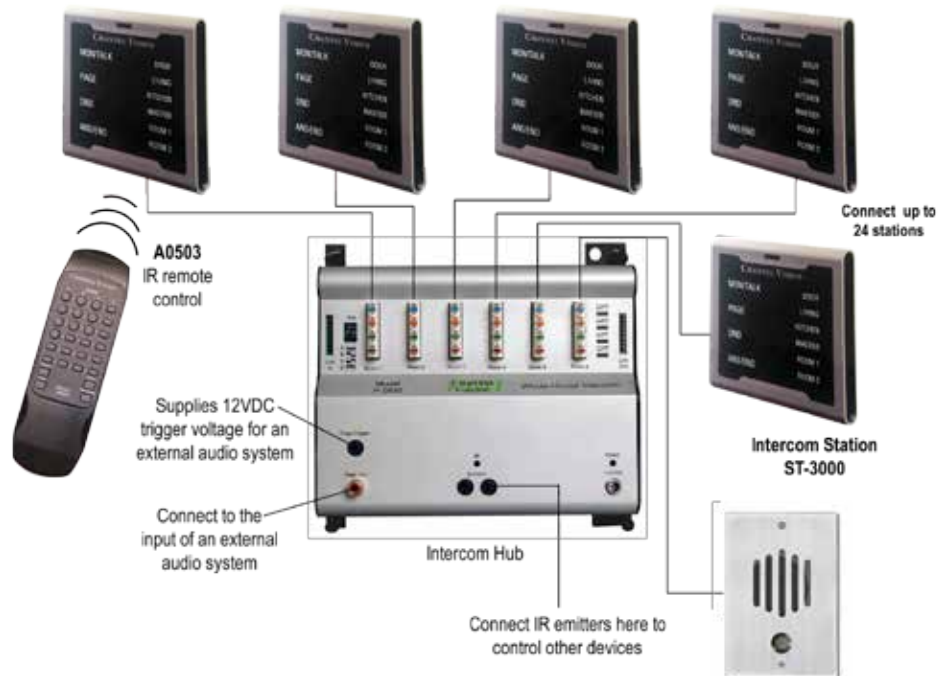

FRONT DOOR STATIONS



DP Series Intercom

- 1/4" Solid Brass
- Available in 8 different finishes
- Surface mount box included
- Flush mount use DP-RBoxIII



IU Series Intercom

- 1/4" Solid Brass
- Hidden camera option available
- Fits into a single gang box (included)

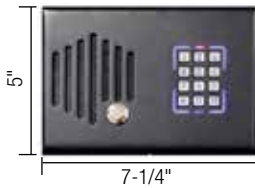

DS3 Series Intercom

- 8 code memory
- Tamper resistant
- Built-in relay
- Fits into 3 gang box (not included)

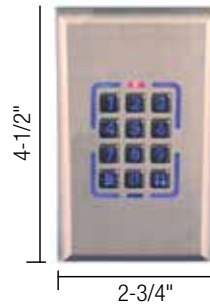

DS-Keypad Access Control

- 8 code access control
- N/O and N/C relay
- Stainless steel face plate

FRONT DOOR STATION ACCESSORIES



DP Series Flush Mount Box

DP-Rbox-III

- Compatible with all DP Front Door Intercom Stations



DP Series Surface Mount Box

DP-9001 Black / DP-9002 White

- Compatible with all DP Front Door Intercom Stations



Intercom Amplifier Kit

NEW TE-AMP

- On-site upgrade for existing DP and IU Series Front Door Intercoms
- P-0920 or P-0921 intercoms

FRONT DOOR INTERCOM CONTROLLERS



1-Door Telephone Intercom Controller

P-0920

- Provides 2-way conversation between front door intercom speaker and every telephone in the house. Simply pick up the phone to begin speaking to the visitor
- Gate strike relay use TE-110DS



2-Door Telephone Intercom Controller

P-0921

- Provides 2-way conversation between two door intercoms and every telephone in the house.
- Two distinctive ring tones when door station is pushed
- Paging through speaker systems



NEW Economy Front Door Intercom Controller

TE-111

- Provides 2-way conversation between front door intercom speaker and every telephone in the house.
- Active phone line required



Door Strike Relay

TE-110DS

- For use with Channel Vision's P-0920, P-0921 or TE-111
- Mounts in a single gang electrical box (not included)
- 12VDC, normally open circuit only

FRONT DOOR INTERCOM KITS



Front Door Intercom Kit

TE-0212 (White) / TE-0282 (Black)

- Kit Includes:
- Front Door Intercom
 - P-0920 Intercom Controller



NEW Front Door Intercom Kit

TE-0252

- TE-0252 Kit Includes:
- IU-0252 Oil Rubbed Bronze Front Door Intercom
 - TE-111 Intercom Controller



Home Intercom Paging Module

P-0925

Channel Vision's Paging Module allows the P-0920/P-0921 to provide an audio output that may be connected to the paging input of the whole house amplifier.

CAT5 INTERCOM SYSTEM



Intercom Station

ST-3000

The Room Intercom Station enables communication directly between rooms, the front door or the entire house.

- Rooms with customized names
- Proxy sensor lights up keypad when near screen
- Hands free communication
- Fits into standard 2 gang box (not included)



Home Intercom System CAT5e Hub

P-0930

The Channel Vision Home Intercom System consists of two basic components: P-0930 Intercom CAT5e Hub and ST-3000 Intercom Station. The system can be expanded through the use of additional Home Intercom System CAT5e Hubs and up to 24 home intercom stations.

CAT5 INTERCOM SYSTEM KIT



Home Intercom System Kit

ST-0935

Channel Vision's Home Intercom System Kit provides direct room-to-room communication and a variety of features not offered by other systems – including a remote control for hands-free calls making whole-house communication from anywhere in the room a snap! The P-0930 Home Intercom Hub can easily be mounted in our structured wiring enclosure and connects to all Home Intercom Stations and Front Door Intercom units with a CAT5e connection. The number of rooms you can communicate with is expandable up to twenty-four (24) intercom stations.

Includes:

- 4 Interior Stations (ST-3000)
- 1 Remote (A0503)
- 1 Home Intercom Hub (P-0930)

CAT5 INTERCOM SYSTEM ACCESSORIES



Outbound Call Forwarding Module

P-0933

- Answer the door from any remote phone number
- Activate the door strike from your cell phone
- Program up to 3 outgoing phone numbers
- For use with P-0930 hub



Home Intercom Station Expander

ST-3100

- Attaches to ST-3000 when expanding the home intercom system
- Provides direct call buttons for 6 additional rooms
- Up to 3 ST-3100 Expanders can be used with 1 ST-3000 (for a total of 24 Stations)



Intercom System Remote Control

A0503

Master remote for Channel Vision's home intercom system. easily controls your home intercom system.

- No programming necessary
- Compatible with: P-0930, ST-2000 and ST-3000



Home Intercom Door Strike Module

ST-C5IDS

The ST-C5IDS is a relay module that provides a contact closure whenever it is activated by the ST-3000 Intercom Station. The contact closure can be used to activate an electronic door strike mechanism or gate opener. This allows the homeowner to answer the door from any intercom station in the house and provide the ability to unlock the door or gate with the press of a button.

- Compatible with ST-2000 & ST-3000 Home Intercom Stations
- Relay settings for N.O. and N.C. Operation
- Variable relay times

SURVEILLANCE SOLUTIONS



Channel Vision offers professional surveillance systems including megapixel IP cameras, hi-resolution analog cameras, network video recorders (NVR), digital video recorders (DVR) and web servers.

FEATURES AND BENEFITS

- Channel Vision's IP cameras, web servers and NVRs allow you to monitor from anywhere in the world using an internet browser or Channel Vision's smartphone application.
- With superior image resolution and IR LEDs for night viewing, images can be viewed live, captured, recorded and sent by email.

CORE COMPONENTS

IP CAMERAS



ANALOG CAMERAS



DIGITAL VIDEO RECORDER



NETWORK VIDEO RECORDER



IP CAMERA & DVR RECORDER SOFTWARE FOR PC



SMARTPHONE APPLICATION



CHANNEL VISION DDNS



CHANNEL VISION CLOUD



CHANNEL VISION ONVIF





Web Support:
www.channelvision.com



Phone Support:
(800) 840-0288 or (714) 424-6500



Email Support:
techsupport@channelvision.com

SURVEILLANCE RECORDING

3G Series DVRs

DVR-43G / DVR-83G / DVR-163G

- Windows and Mac compatible
- 3G mobile phone monitoring supports iPhone®, Blackberry®, Windows® and Android® mobile phones
- Internet viewing through Internet Explorer®, Safari®, and Firefox®
- CMS supports up to 16 DVRs with 64 cameras (included)
- AVI watermark converter transfers data with a time stamp for use as legal evidence



NEW

Network Video Recorders

NVR-4

- 4 IP camera audio and video recorder
- Access from monitor, internet or smartphone
- Supports PPPoE, Static, DHCP IP and DDNS
- ONVIF cameras support



SURVEILLANCE KITS



Hidden DVR Kit

DVR-43GKIT1

- 4 Channel DVR in Enclosure with 500GB Drive
- IR Repeating System included



NEW

Camera & DVR Kit

DVR-43GKIT2

- 4 Channel DVR with 500GB Drive
- 4 Outdoor 6332-0 IR bullet cameras



NEW

Camera & DVR Kit

DVR-43GKIT3

- 4 Channel DVR with 500GB Drive
- 4 Outdoor 6821-0 IR varifocal cameras

WEB SERVERS



1-Camera Web Server

W-1001

- 1 Analog Camera Input Converts to IP
- SD card back-up
- Support smart phone / PDA / 3GPP
- Triple streaming



4-Camera Web Server

W-4001

- 4 Analog Cameras convert to IP
- RS-485 Control Interface (PTZ)
- SD card back-up
- Supports Smart Phones/3GPP/PDA



BALUNS



IP Camera Balun Over Coax Converter Kit

B-204

- Uses legacy analog video cabling RG-59 or RG-6
- IP camera over 300ft cable runs
- Transmitter and receiver included



Amplified Balun Kit

B-321

- Sends analog video 7,000 ft. on CAT5
- 2 Power supplies included



CAT5 Camera Sequencer

P-6014

- 4 camera switcher
- CAT5 balun input
- RS232 Control



1 Camera CAT5 Passive Video Balun

B-201

- Sends video 1,000ft. on twisted pair



CAT5 Camera Balun for Camera, Audio & Power

B-300

- Includes both transmit and receive units
- Sends video, power and audio 1,000ft. on CAT5



CAT5 Balun Audio, Video & Power Interface

3112

- Converts any standard camera to CAT5 cable
- Works with the P-6014 CAT5 Camera Sequencer

SURVEILLANCE ACCESSORIES



Camera Swivel Mount
5030



Wall Mount for 6106, 6126,
6127 and 6901 Dome
5034



Wall Mount for 6810
5038



NEW Junction Box for 6543
5039



IR Illuminator 33ft.
5040



NEW Wallmount for 6564
5042



NEW 9 Camera Power Supply
5011



NEW 18 Camera Power Supply
5012



Camera Power Supply
5015PS - 500mA
5017PS - 1000mA



Camera Microphone
5104-MIC

IP CAMERAS

SKU	CAMERA	INDOOR/ OUTDOOR	RESOLUTION	LUX VALUE	LENS	ADDITIONAL INFORMATION
6524-W 6524-B		Outdoor	1.3 Megapixel	1.0 Lux	Fixed 4.2mm	Flush Mount Double-Gang Box included SDDP (Simple Device Discovery Protocol) for Control4 included, No POE Support
6531		Indoor	1.3 Megapixel	0 Lux (IR On)	Fixed 4.2mm	Built-in IR viewing distance of 15ft. SDDP (Simple Device Discovery Protocol) for Control4 included, No POE Support
6532		Outdoor	1.3 Megapixel	1.0 Lux	Fixed 4.2mm	Mini Vandal Proof IP66 Rated Housing & POE SDDP (Simple Device Discovery Protocol) for Control4 included
6543		Outdoor	2 Megapixel	0 Lux (IR On)	Varifocal 3.6-16mm	35 IR LED for a viewing distance of 60 feet IP66 Waterproof Rating, POE SDDP (Simple Device Discovery Protocol) for Control4 included
6544		Outdoor	1.3 Megapixel	0 Lux (IR On)	Varifocal 3.3-12mm	35 IR LED for a viewing distance of 65 feet WIFI 802.11 n,b,g wireless or wired SDDP (Simple Device Discovery Protocol) for Control4 included
6564		Outdoor	2 Megapixel	0 Lux (IR On)	Varifocal 3-9mm	18 IR LED for a viewing distance of 45 feet IP66 Waterproof Rating, POE SDDP (Simple Device Discovery Protocol) for Control4 included
6564-H		Outdoor	2 Megapixel	0 Lux (IR On)	Varifocal 3-9mm	18 IR LED for a viewing distance of 45 feet IP66 Waterproof Rating, POE, Heater SDDP (Simple Device Discovery Protocol) for Control4 included





CHANNEL VISION'S IP CAMERAS ARE BATTLE TESTED WITH:



BULLET ANALOG CAMERAS

SKU	CAMERA	INDOOR/ OUTDOOR	RESOLUTION	LUX VALUE	LENS	ADDITIONAL INFORMATION
6325-S		Outdoor	420TVL	0.92 LUX	Fixed 3.6mm	Universal Swivel Mount Included
6332-O 6332-W		Outdoor	650TVL	0 Lux (IR On)	Varifocal 4-9mm	IP66 waterproof, smart IR for 45ft. viewing in complete darkness

DOME ANALOG CAMERAS

SKU	CAMERA	INDOOR/ OUTDOOR	RESOLUTION	LUX VALUE	LENS	ADDITIONAL INFORMATION
6126-B 6126-W		Indoor	540TVL	0 Lux (IR On)	Fixed 3.6mm	LED for a viewing distance of 60 feet Automatic Gain Control and Auto White Balance
6127		Outdoor	700TVL	0 Lux (IR On)	Varifocal 3.7-12mm	24 IR-LED's for night viewing up to 65' Vandal proof IP66 rated construction
6810-O 6810-W		Outdoor	700TVL	0 Lux (IR On)	Fixed 3.6mm	Available in Oil Rubbed Bronze or White Vandal proof IP66 rated construction
6821-O 6821-W		Outdoor	700TVL	0 Lux (IR On)	Varifocal 2.8-12mm	Available in Oil Rubbed Bronze or White Vandal proof IP66 rated construction WDR (Wide Dynamic Range), OSD (On-screen display)
6901		Outdoor	700TVL	0 Lux (IR On)	Varifocal 2.8-10.5	24 IR-LED's for night viewing up to 65' Vandal proof IP66 rated construction WDR (Wide Dynamic Range)

SPECIALTY ANALOG CAMERAS

SKU	CAMERA	INDOOR/ OUTDOOR	RESOLUTION	LUX VALUE	LENS	ADDITIONAL INFORMATION
6002 FMC-II		Outdoor	550TVL	0.2 Lux	Fixed 5.5mm	Smoked acrylic with white decorative cover Two Gang Mud Ring included
6200		Outdoor	550TVL	0.2 Lux	Fixed 5.5mm	Smoked acrylic with 7 different finishes Fits into standard 1 Gang Box
6204		Outdoor	560TVL	0.1 Lux	Fixed 5.5mm	Smoked acrylic with 7 different finishes WDR (Wide Dynamic Range) Camera
6710		Outdoor	560TVL	0.2 Lux	3.94-46mm	12x optical zoom, 360° pan, 90° tilt Right angle wall mount bracket included
6721		Outdoor	550TVL	0.4 Lux	3.5-94.5mm	27x optical zoom, 360° pan, 90° tilt Right angle wall mount bracket included
6403		Indoor	550TVL	0.2 Lux	Fixed 5.5mm	5.5mm lens for tight viewing angles 1"x1" ultra compact design
6404		Indoor	560TVL	0.1 Lux	Fixed 5.5mm	5.5mm lens for tight viewing angles WDR (Wide Dynamic Range)

ENTERTAINMENT



Crank up the volume! ARIA multi-room audio distribution delivers powerful room amplification. Combine it with our audio/video matrix for complete control of the system from any room. Choose your wiring options from traditional speakers with control wire, CAT5 or wireless, we have a solution for your listening pleasure. Channel Vision's ARIA speakers include a full line of in-ceiling, in-wall, outdoor and a full line of builder series speakers - all finely crafted to provide high quality sound throughout the Well-Connected Home™.

FEATURES AND BENEFITS

- Up to four different sources can be played in 16 different zones simultaneously, perfect for families with a variety of listening interest
- On-wall iPod docks over CAT5 allow you to listen, charge and control your iPod music and video from any room in your home or business
- In-ceiling, in-wall and outdoor speakers feature high power handling capability providing true stereo sound quality, not simply background music
- IR Repeater Systems provide single room and multi-room control over existing TV coax or CAT5 wire

CORE COMPONENTS

AMPLIFICATION



SOURCE INPUT



VOLUME CONTROL



SPEAKERS



IR CONTROL SYSTEMS





Web Support:
www.channelvision.com



Phone Support:
(800) 840-0288 or (714) 424-6500



Email Support:
techsupport@channelvision.com

ARIA™ WIRING DIAGRAM

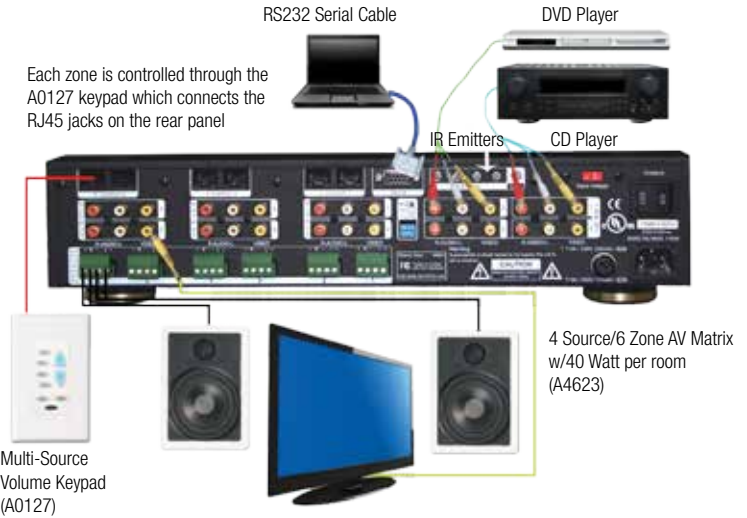

- 4 AV sources to 6 zones
- Expands to 18 zones with 3 units
- All inclusive matrix and amplifier system
- Drivers available for:



ARIA AUDIO/VIDEO KITS



Six-Zone Audio Kit

A-KIT 1 / A-KIT 2 Includes 6 Pairs of Speakers

- 1 each: Multi-Room A/V Matrix (A4603)
- 1 each: Power Amplifier (A1260)
- 6 each: A/V Interconnects
- 4 each: IR emitter (IR-3002)
- 6 each: Keypads (A0127)
- 1 each: Remote Control
- Available in Ivory/Almond (A-KIT 11A / A-KIT 21A)

ARIA AUDIO DISTRIBUTION



ARIA Multi-Zone Audio Amplifier

A1260 / A1260R

- 12-channel amplifier
- (17" component style)
- Also available in a 3-rack units high 19", rack mount version (A1260R)
- 120 watts per zone, class A/B amp
- Each zone may be switched between the global input and the local input



ARIA 4 Input 6 Zone Matrix AV Controller

A4603 / A4603R

- IR Remote control and RS-232 Serial Control for Touch Screens
- Pre-amp Outputs are a perfect match for the A1260 Amplifier
- Expandable to 18 zones



ARIA 4 Input 6 Zone Matrix & Amplifier

A4623 / A4623R

- Built-in Amplifiers: 40 watts per zone
- Pre-amp outputs for adding more amplification
- IR and Serial Control
- Expandable to 18 zones

ARIA VOLUME CONTROL



ARIA Multi-Source Volume Control

A0127

- Volume Control for the A4603 and A4623 matrix products
- 4 source selection customizable buttons
- Integrated IR Repeating system



Impedance Matching Volume Control

VC-302

- 300 watts peak, 100 watts RMS per channel
- Impedance matching up to 8 pairs of speakers



VC-302 Accessory Kit

VC-31V / VC-3AL

- Color kit for VC-302 impedance matching volume control
- Available in Ivory VC-31V
- Available in Almond VC-3AL

ARIA IPOD DOCKS



ARIA On-Wall Dock for iPod®

A0316

- RS-232 interface for automation systems and album art
- Keeps the iPod charged
- Allows viewing of iPod videos on a TV
- Integrated IR Control Repeating system



NEW On-Wall Dock Station for iPad®

A0602 White / A0604 Black

- The perfect companion for Automation Systems
- iPad is always charged and always right where you left it
- Lighting or 30 pin
- Hinged door allows the iPad Gen 2 and 3 to be removed
- 3 Gang J Box required

ARIA ACCESSORIES



CAT5 Audio / IR Transmitter and Receiver

A0304



A/V System Remote Control

A0505

A-BUS WIRING DIAGRAM

- 4 sources input of RCA or CAT5
- 4 zones, expandable to 16
- 300ft. CAT5 wiring to each keypad amp
- Control source equipment with IR
- Ability to integrate a local source override with an iPod dock or alternative source

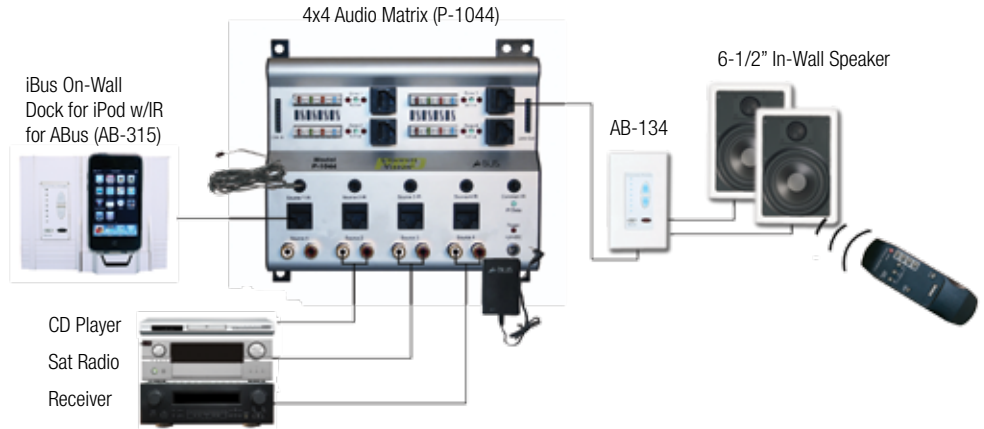

A-BUS AUDIO/VIDEO KITS



A-BUS 1 Source 4 Zone Complete Audio Kit

AB-902 / AB-901 Includes 4 Pairs of Speakers

- 4 each: Amplified Keypad (AB-134)
- 1 each: Single Source Module (AB-203)
- 1 each: 4-Zone Distribution (AB-404) w/power
- 1 each: Remote Control (A0505)
- 2 each: Dual IR Flasher (IR-3002)
- Available in Ivory/Almond (AB-901IA/AB-902IA)



A-BUS 4 Source 4 Zone Audio Kit

AB-904

- 1 each: 4 Source, 4 Room ABUS Matrix (P-1044)
- 4 each: 4 Source Amplified Keypad (AB-134)
- 4 each: Single Head IR Emitter (IR-3001)
- 1 each: Remote Control (A0505)
- 1 each: Punch Down Tool (J-110 Tool)
- Available in Ivory/Almond (AB-904IA)

A-BUS AUDIO DISTRIBUTION



A-BUS Single-Source Distribution Module

AB-203

- Single CAT5 output for audio distribution with AB-404
- 2 IR emitter outputs for control of audio equipment



NEW A-BUS 1 Input 2 Zone Audio Distribution

AB-402

- Local and CAT5 source input
- 2 zones, Power and IR
- *Requires 2 gang box



A-BUS Panel Distribution Module

AB-404

- Accepts source from AB-203 or AB-301 and distributes to 4 zones
- Expansion to an unlimited number of zones
- *Requires power supply AB-T2454



A-BUS 1 Input 4 Zone Audio Distribution

P-1014

- Local and system audio inputs with selectable priority
- Expansion to an unlimited number of zones



A-BUS 4 Input 4 Zone Audio Matrix

P-1044

- Expandable to 16 zones

A-BUS VOLUME CONTROL



NEW A-BUS Multi-Source Volume Control

AB-134W

- High output class D amp design
- Remote or local push-button control
- Back-lit keypad with blue LED indicators



NEW A-BUS Low Cost Volume Control

AB-135W

- High output class D amp design
- Back-lit keypad with green LED indicators

A-BUS ACCESSORIES



A-BUS Local Source Module

AB-301



NEW A-BUS Local Source Bluetooth Module

AB-303

A-BUS IPOD DOCKS



A-BUS On-Wall Dock for iPod

AB-315

- Compatible with all A-BUS Audio Systems
- Charges iPod

*Shown with AB-134 not included



A/V System Remote Control

A0505



Power Supply

AB-T2454

CRESCENDO™ WIRING DIAGRAM

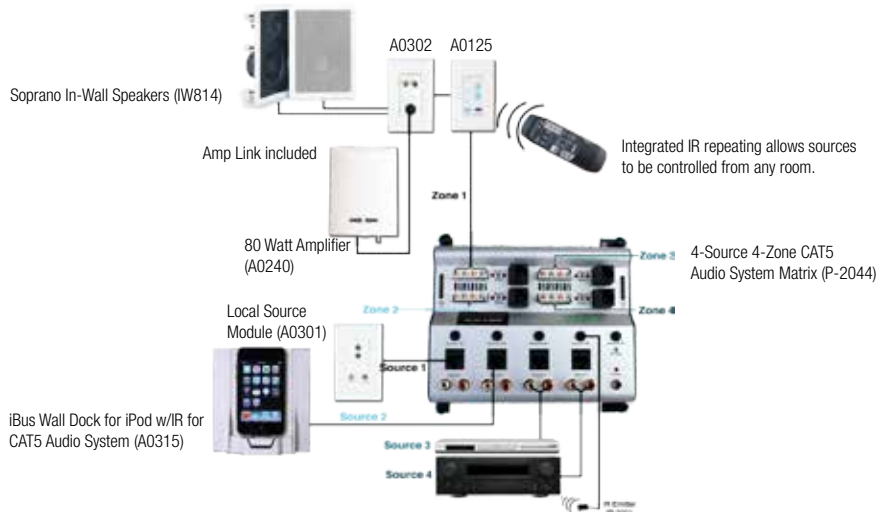

CRESCENDO™ AUDIO/VIDEO KITS



CRESCENDO™ Room Kit

A0910

- 1 each: 80 Watt Class D Amplifier (A0240)
- 1 each: Speaker to Line Level Converter (A0302)
- 1 each: CAT5 Audio System Keypad (A0125)

CRESCENDO™ Room Kit

A0912

- 4 each: 80 Watt Class D Amplifier (A0240)
- 4 each: Speaker to Line Level Converter (A0302)
- 4 each: CAT5 Audio System Keypad (A0125)
- 2 each: IR emitter (IR-3002)
- 1 each: 1-Source x 4-Zone Audio Hub (P-2014)



CRESCENDO™ Room Kit

A0914

- 1 each: 4x4 Matrix Distribution Hub
- 4 each: 80 Watt Class D Amplifier (A0240)
- 4 each: Speaker to Line Level Converter (A0302)
- 4 each: CAT5 Audio System Keypad (A0125)
- 4 each: IR emitter (IR-3001)
- 1 each: 4-Source x 4-Zone Audio Hub (P-2044)

CRESCENDO™ On-Wall Dock Single Room Kit

A0915

- iBus Wall Dock for iPod - A0315
- 100W Amplifier - A0350
- Keypad Controller - A0129
- In-Ceiling Speakers (one pair) - IC608



CRESCENDO™ AUDIO DISTRIBUTION



CRESCENDO™ 80w Class D Amplifier

A0240

- 80 Watt amplifier
- Audio-sensing power shut-off to conserve energy



CRESCENDO™ Audio Subwoofer Connection

A0302

- Provides line-level output for re-amplification
- Sub mode allows a subwoofer to be added to an audio system



CRESCENDO™ 100 Watt Flush Mount Amplifier

A0350

- Pre-amp audio outputs for powered subwoofer
- Local audio input
- Power saving audio sensed circuit
- Multi-Room amp with P-2014 or a P-2044



CRESCENDO™ 4 Input 4 Zone Audio Matrix

P-2044

- Expandable to 16 zones



CRESCENDO™ 1 Input 4 Zone Distribution

P-2014

- Local and system audio inputs with selectable priority
- Expansion to an unlimited number of zones

CRESCENDO™ VOLUME CONTROL



CRESCENDO™ Volume Control

A0125

- Digital volume control for P-2014 and P-2044
- Integrated IR Repeating System



CRESCENDO™ Volume Control

A0129

- 1-Zone Volume Control for the A0350 in-wall amplifier
- Integrated IR Repeating system

CRESCENDO™ IPOD DOCKS



On-Wall Dock for iPod

A0315

- Local source iPod Dock
- Charges iPod
- Use with A0350, P-2044 or P-2014

*Shown with A0125 Keypad not included

CRESCENDO™ ACCESSORIES



CRESCENDO™ CAT5 Local Source Module

A0301



A/V System Remote Control

A0505

IR REMOTE CONTROL DIAGRAM

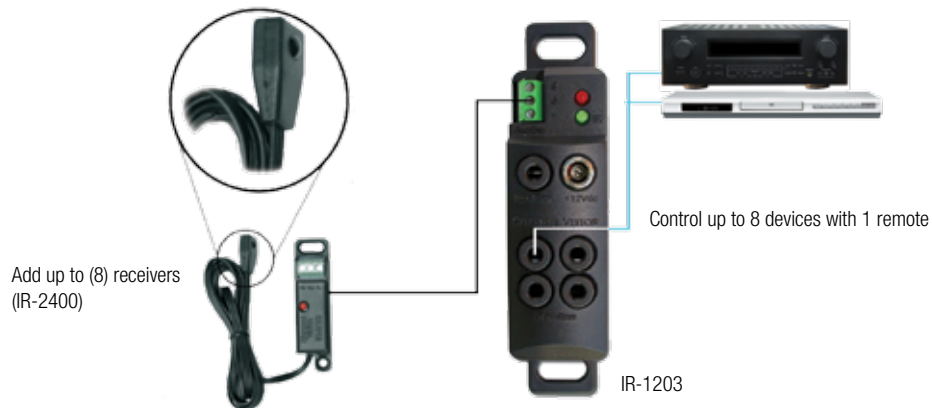

IR REMOTE CONTROL KITS



IR Repeater System All-in-One Kit

IR-5000

Easily connect the IR Repeater System All-in-One Kit - IR-5000 and control Home Theater A/V devices located behind closed cabinet doors.



IR Repeater Kit

IR-5010

Receiver can be 1000 feet from hub.

- 1 each: IR Receiver - IR-2400
- 1 each: IR Hub - IR-1203
- 2 each: Dual head IR emitter - IR-3002
- 12 V power supply

IR REMOTE CONTROL



IR Repeater Amplified Hub

IR-1203

- 4 IR emitter outputs



IR Repeater System Receiver

IR-2400

- Mini IR receiver head, desk top or bullet in 1 part
- Plasma, sunlight, LED proof



IR Repeater System Emitter

IR-3001

- Single IR - Emitter/Flasher



IR Repeater System Dual Emitter

IR-3002

- Holster holds flasher in place, move equipment without re-gluing on the equipment



IR Repeater Over Coax Engine

IR-4000

- Power 4 IR receivers with one power supply
- Maximum distance to IR Repeater emitters is 500ft.
- *Use IR-4101 Only



IR Repeater Over Coax Receiver

IR-4101

- Coax IR Repeater Receiver
- Compatible with: IR-4000, E2200IR, E4200IR, P-0321, and P-0328



IR Bypass Cable

IR-4180

- 3.5 to 3.5mm IR patch cable
- Use with audio stereo plug
- Use with IR over coax



J-Box IR Repeater Receiver

IR-2005

- Designed for use with single- or multi-room IR Repeater Systems (IR-2400 inside)
- Includes decorator style trim ring



IR Repeater Distribution Module

C-1201

- Combines signals from 8 IR Repeater Receivers
- Provides 1 simple output to your amplified IR repeater hub
- Mounts in Channel Vision's structured wire enclosures



IR Breakout Insert

G-IRB-W

- 3.5 mm plug for IR receivers or emitters
- 3-wire terminal connection
- Great for 3.5 mm audio to CAT5 conversion

IN-CEILING SPEAKERS - 10 YEAR WARRANTY



Builder Series 5.25" In-Ceiling Speaker

IC504

- 5.25" in-ceiling loudspeaker
- Polypropylene woofer with butyl rubber surround



Builder Series 6.5" In-Ceiling Speaker

IC608

- 6.5" in-ceiling loudspeaker
- High compliance polymer tweeter,
- Polypropylene woofer with butyl rubber surround



Soprano Series 5.25" In-Ceiling Speaker

IC514

- 5.25" High Performance 100W speaker
- Kevlar woofer with 1" pivoting tweeter



NEW Soprano Series 6.5" In-Ceiling Speaker

IC615

- 6.5" High Performance 120 watt Speaker
- 1" Ferrofluid Cooled Silk Dome Tweeter
- Ultra-thin bezel magnetically mounted grill



NEW Soprano Series 8" In-Ceiling Speaker

IC815

- High Performance 8" 150 watt Speaker
- 1" Ferrofluid Cooled Silk Dome Tweeter
- Ultra-thin bezel magnetically mounted grill



NEW Soprano Series 6.5" Angled In-Ceiling Speaker

IC626

- 6.5" High performance speaker
- 15° Angled woofer
- Ultra-thin bezel magnetically mounted grill



NEW Soprano Series 8" Angled In-Ceiling Speaker

IC825

- 8" High performance speaker
- Pivoting tweeter technology with 1" voice coil
- Ultra-thin bezel magnetically mounted grill

IN-WALL SPEAKERS



Builder Series 6.5" In-Wall Speaker

IW603

- 1/2" Polymer Tweeter
- Small perforated designer grill
- 3.7" Depth



NEW Soprano Series 6.5" In-Wall Speaker

IW615

- Pivoting 1" tweeter
- 6.5" butyl rubber surround with 20oz. magnet
- Ultra-thin bezel magnetically mounted grill



Soprano Series 8" In-Wall Speaker

IW814

- 8" high performance 120 Watt
- Pivoting 1" voice coil, enclosed, rare earth neodymium magnet
- 8" Kevlar, butyl rubber surround with 24oz. magnet



Soprano Series 6.5" LCR In-Wall Speaker

LCR625

- Dual 6.5" Mica filled polypropylene with Butyl rubber surround
- Pivoting 1" silk soft dome tweeter
- Home theater left, center, right

OUTDOOR SPEAKERS



Soprano Series 5.25" Outdoor Speaker

OS526

- Weather resistant aluminum grilles, brackets and stainless steel hardware
- UV protected cabinet resists sun fade
- 5.25" woofer with 20oz magnet
- 160 Watt



Soprano Series 6.5" Outdoor Speaker

OS611

- Weather resistant aluminum grilles, brackets and stainless steel hardware
- UV protected cabinet resists sun fade
- 6.5" woofer with 20oz magnet
- 200 Watt



Soprano Series 8" Outdoor Speaker

RS802-GR / RS801-SA

- 8" High Performance 160 Watt speaker
- Waterproof tweeter with 1" voice coil
- Polypropylene cone woofer with butyl rubber surround

WIRELESS AUDIO DISTRIBUTION



Wireless Audio Transmitter

WA-320: 1 Source to 1 Destination

WA-321: 1 Source to Many Destinations

- Wirelessly transmits audio up to 300' ft.
- Line-level and speaker level audio inputs
- 3.8 micro second latency, undetectable to the human ear
- 2.4GHz operating frequency offers clear, undistorted audio



Wireless Receiver with Amplifier

WA-350: 1 Destination from 1 Source

WA-351: Many Destinations from 1 Source

- Receive wireless audio from up to 300ft. away
- 100 Watt integrated class D amplifier
- Pre-amp audio outputs for easy connection to powered subwoofer
- Local audio input to override the wireless audio signal



Wireless Audio Transmitter

WA-360: 1 Destination from 1 Source

WA-361: Many Destinations from 1 Source

- Wirelessly receives audio up to 300ft.
- Standard Line-level audio outputs
- 3.8 micro second latency, undetectable to the human ear
- 2.4GHz operating frequency offers clear, undistorted audio



Wireless Receiver Wall-Mount Brackets

WA-32WM

WA-36WM



 **CHANNEL VISION™**
234 Fischer Ave. Costa Mesa, CA 92626 USA
800.840.0288 • 714.424.6500
sales@channelvision.com
www.channelvision.com

Control4 CasaTunes' pakedge device&software inc. VIDEOINSIGHT  CRESTRON

LUXUL WIRELESS QNAP QNAP SYSTEMS, INC.  PREMIERE SAVANT Partner in Excellence  BITWISE CONTROLS COUPE AUTOMATION  EXTRA  NEXT LEVEL SECURITY SYSTEMS  RTI



Channel Vision Technology, Channel Vision Central, Channel Vision PRO, ARIA, AFFINITY, Soprano, Crescendo and iBus are trademarks of Channel Vision Technology. A-BUS® is a registered trademark of LeisureTech Electronics Pty Ltd, Australia, and may be covered by one or more of the following patents US 7, 181, 023, 6, 389, 139, EP 1004222, AU 739808, NZ 502982, Mexico Z41196, Canada CA2301062. iPod is a trademark of Apple Inc., registered in the U.S. and other countries. All other trademarks remain the property of their respective holders. This material is copyrighted in its entirety and no duplications or representations in any format are allowed without the prior written consent of Channel Vision Technology. Specification and part numbers are subject to change without notice. Channel Vision Technology is not responsible for errors or omissions. Copyright © 2014 Channel Vision Technology. All rights reserved.